

Stainless steel storage cupboard with 2 sliding doors - integrated inclined hygienic dust-proof top

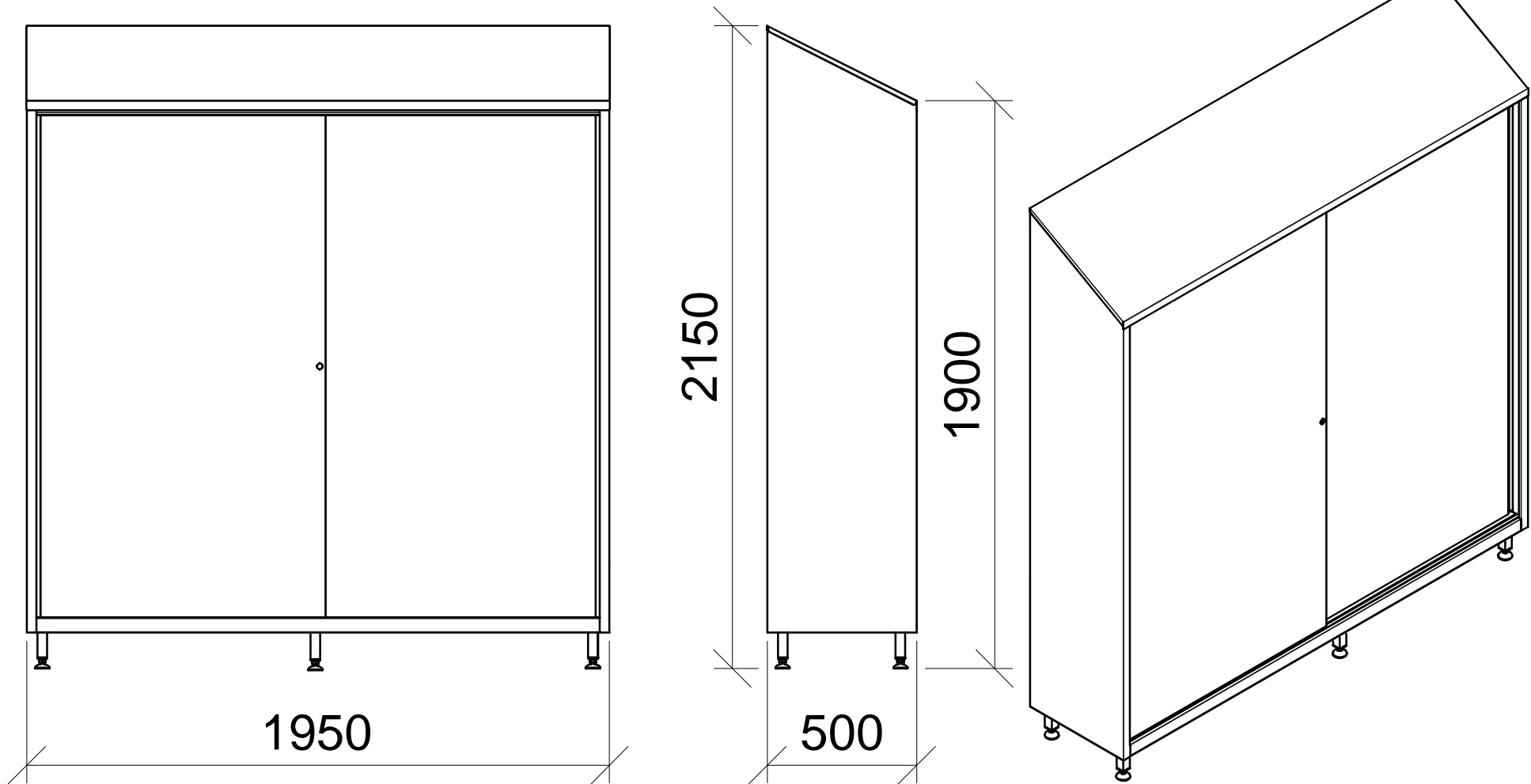

Dimensions in mm



CHARACTERISTICS: 19 gauge

Central vertical partition

- 1,0 mm thick stainless steel;
- 2J finish (Scotch-Brite®);
- Dustproof slanting top;
- Cylindrical key pressure lock;
- 4+4 adjustable shelves with stainless pegs;
- Adjustable feet.

Code: X6027



Via Lazio 7 A/B/C - 41050 Montale Rangone (MO)
Web: www.facilitas.it @: facilitas@facilitas.it
Tel:+39 (0)59-530570 Fax:+39 (0)59-4909000