

Stainless steel storage cupboard with 2 sliding doors - flat top

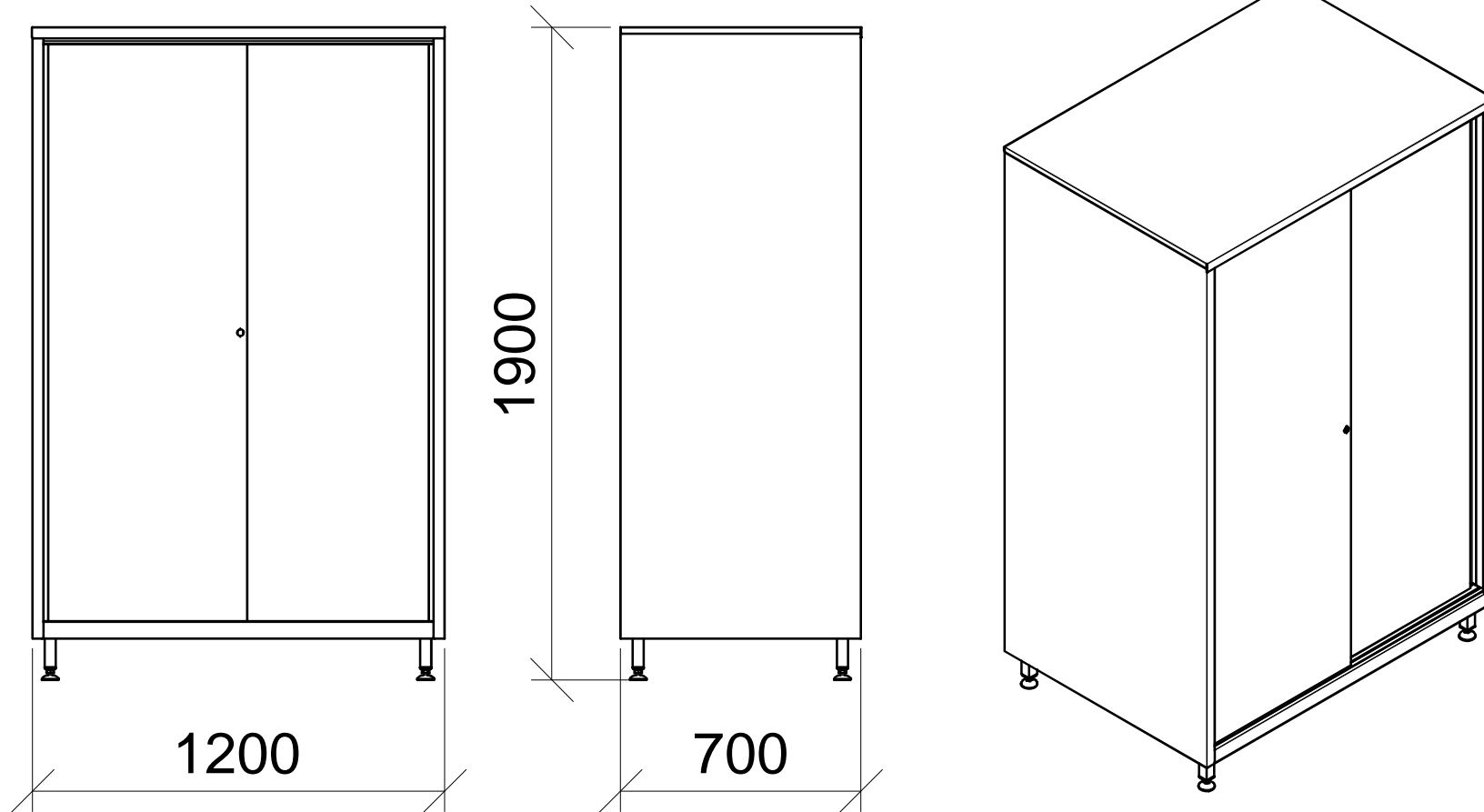

Dimensions in mm



CHARACTERISTICS: 19 gauge

- 1,0 mm thick stainless steel;
- 2J finish (Scotch-Brite®);
- Flat top;
- Cylindrical key pressure lock;
- 4 adjustable shelves with stainless pegs;
- Adjustable feet.

Code: X6039

FACILITAS

Via Lazio 7 A/B/C - 41050 Montale Rangone (MO)
Web: www.facilitas.it @: facilitas@facilitas.it
Tel: +39 (0)59-530570 Fax: +39 (0)59-4909000